



DS 401

Intelligent Electronic Pressure Switch Stainless Steel

Ceramic Sensor

accuracy according to IEC 60770:
0.5 % FSO

Nominal pressure

from 0 ... 400 mbar up to 600 bar

Contacts

1 or 2 independent PNP contacts,
freely configurable

Analogue output

2-wire: 4 ... 20 mA

3-wire: 4 ... 20 mA

3-wire: 0 ... 10 V (on request)

others on request

Special characteristics

- ▶ indication of measured values on a 4-digit LED display
- ▶ rotatable and configurable display module

Optional versions





- ▶ **IS-version**
Ex ia = intrinsically safe for gases and dust
- ▶ pressure port PVDF
- ▶ customer specific versions

The electronic pressure switch DS 401 is the successful combination of

- ▶ intelligent pressure switch
- ▶ digital display

and has been specially designed for universal usage in industry applications; with flush diaphragm the DS 401 is suitable for the usage in viscous, pasty or highly contaminated media. The rotatable stainless steel globe housing is predestined for rough conditions and difficult installing conditions, caused by the high functionality and robustness. As standard the DS 401 offers a PNP contact and is optionally available with a second, independent contact. Additionally the DS 401 could be equipped with an analogue output.

Preferred areas of use are

-  Plant and machine engineering
-  Environmental engineering
(water – sewage – recycling)
-  Water
-  Hydraulic oil



Input pressure ranges																		
Nominal pressure gauge [bar]	-1...0	0.4	0.6	1	1.6	2.5	4	6	10	16	25	40	60	100	160	250	400	600
Nominal pressure abs. [bar]	-	-	0.6	1	1.6	2.5	4	6	10	16	25	40	60	100	160	250	400	600
Level gauge [mH ₂ O]	-	4	6	10	16	25	40	60	100	160	250	400	600	-	-	-	-	-
Overpressure [bar]	4	1	2	2	4	4	10	10	20	40	40	100	100	200	400	400	600	800
Burst pressure ≥ [bar]	7	2	4	4	5	5	12	12	25	50	50	120	120	250	500	500	650	880
Vacuum resistance	P _N ≥ 1 bar: unlimited vacuum resistance P _N < 1 bar: on request																	
Contact ¹																		
Number, type	standard: 1 PNP contact option: 2 independent PNP contacts																	
Max. switching current	4 ... 20 mA / 2- and 3-wire: contact rating 125 mA, short-circuit resistant; V _{Switch} = V _S - 2V 0 ... 10 V / 3-wire (on request): contact rating 125 mA, short-circuit resistant																	
Accuracy of contacts ²	≤ ± 0.5 % FSO																	
Repeatability	≤ ± 0.2 % FSO																	
Switching frequency	2-wire: max. 10 Hz / 3-wire: 50 Hz																	
Switching cycles	> 100 x 10 ⁶																	
Delay time	0 ... 100 sec																	
¹ with Ex-protection max. 1 contact possible																		
Analogue output (optionally) / Supply																		
2-wire current signal	4 ... 20 mA / V _S = 13 ... 36 V _{DC} permissible load: R _{max} = [(V _S - V _{Smin}) / 0.02 A] Ω response time: < 10 msec																	
2-wire current signal, Ex-protection	4 ... 20 mA / V _S = 15 ... 28 V _{DC} permissible load: R _{max} = [(V _S - V _{Smin}) / 0.02 A] Ω response time: < 10 msec																	
3-wire current signal	4 ... 20 mA / V _S = 24 V _{DC} ± 10 % adjustable (turn-down of span 1:5) ³ permissible load: R _{max} = 500 Ω response time: < 30 msec																	
3-wire voltage signal (on request)	0 ... 10 V / V _S = 24 V _{DC} ± 10 % adjustable (turn-down of span 1:5) ³ permissible load: R _{min} = 10 kΩ response time: < 30 msec																	
Without analogue output	V _S = 15 ... 36 V _{DC}																	
Accuracy ²	≤ ± 0.5 % FSO																	
² accuracy according to IEC 60770 – limit point adjustment (non-linearity, hysteresis, repeatability)																		
³ with turn-down of span the analogue signal is adjusted automatically to the new measuring range																		
Thermal effects (Offset and Span) / Permissible temperatures																		
Thermal error	≤ ± 0.2 % FSO / 10 K																	
in compensated range	-25 ... 85 °C																	
Permissible temperatures	medium: -40 ... 125 °C electronics / environment: -40 ... 85 °C storage: -40 ... 100 °C																	
⁴ for pressure port of PVDF the minimum permissible temperature is -30 °C																		
Electrical protection																		
Short-circuit protection	permanent																	
Reverse polarity protection	no damage, but also no function																	
Electromagnetic compatibility	emission and immunity according to EN 61326																	
Mechanical stability																		
Vibration	10 g RMS (25 ... 2000 Hz) according to DIN EN 60068-2-6																	
Shock	500 g / 1 msec according to DIN EN 60068-2-27																	
Materials																		
Pressure port / housing	standard: 1.4404 (316L) option for G1/2" open port (up to 60 bar): PVDF																	
Housing	1.4404 (316L)																	
Display housing	stainless steel 1.4301 (304)																	
Viewing glass	laminated safety glass																	
Seals	standard: FKM option: EPDM (P _N ≤ 160 bar) others on request																	
Diaphragm	ceramics Al ₂ O ₃ 96 %																	
Media wetted parts	pressure port, seals, diaphragm																	

Explosion protection (only for 4 ... 20 mA / 2-wire)	
Approval AX14-DS 401	IBExU06ATEX1050 X zone 0: II 1G Ex ia IIC T4 Ga (connector) / II 1G Ex ia IIB T4 Ga (cable) zone 20: II 1D Ex ia IIIC T135 °C Da
Safety technical maximum values	$U_i = 28\text{ V}$, $I_i = 93\text{ mA}$, $P_i = 660\text{ mW}$, $C \approx 0\text{ nF}$, $L_i \approx 0\text{ }\mu\text{H}$
Max. switching current ⁵	70 mA
Permissible temperatures for environment	-20 ... 60 °C with p_{atm} 0.8 bar up to 1.1 bar
Connecting cables (by factory)	cable capacitance: signal line/shield also signal line/signal line: 100 pF/m cable inductance: signal line/shield also signal line/signal line: 1 $\mu\text{H}/\text{m}$
⁵ the real switching current in the application depends on the power supply unit	
Miscellaneous	
Display	4-digit, 7-segment-LED display, visible range 37.2 x 11 mm; digit height 10 mm, range of indication -1999 ... +9999; accuracy 0.1 % \pm 1 digit; digital damping 0.3 ... 30 sec (programmable); measured value update 0.0 ... 10 sec (programmable)
Option oxygen application ⁶	for $P_N \leq 25\text{ bar}$: O-ring in FKM Vi 567 (with BAM-approval); permissible maximum values are 25 bar / 150° C
Current consumption (without contacts)	2-wire signal output current: max. 25 mA 3-wire signal output current: approx. 30 mA + signal current 3-wire signal output voltage: approx. 30 mA
Ingress protection	IP 67
Installation position	any
Weight	approx. 400 g
Operational life	100 million load cycles
CE-conformity	EMC Directive: 2014/30/EU Pressure Equipment Directive: 2014/68/EU (module A) ⁷
ATEX-Richtlinie	2014/34/EU
⁶ not possible with flush pressure ports	
⁷ This directive is only valid for devices with maximum permissible overpressure > 200 bar	
Wiring diagrams	
<p>2-wire-system (current)</p>	<p>3-wire-system (current / voltage)</p>
Pin configuration	
Electrical connections	M12x1 metal (5-pin)
Supply +	1
Supply -	3
Signal + (only 3-wire)	2
Contact 1	4
Contact 2	5
Shield	plug housing / pressure port
Electrical connections (dimensions in mm)	
<p>M12x1 (5-pin)</p>	
Design ⁸	
<p>side display 45° display (on request)</p>	
⁸ all designs in horizontal rotatable housing as standard	

Mechanical connections (dimensions in mm)

standard

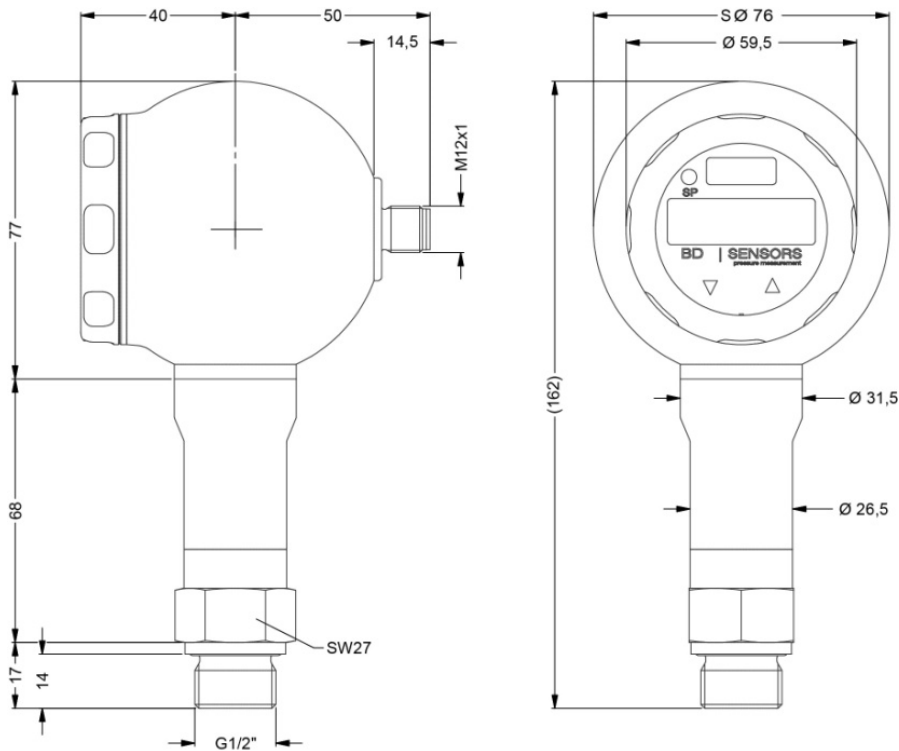

G1/2" DIN 3852

optionally

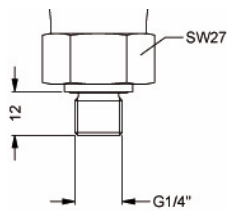

G1/4" DIN 3852

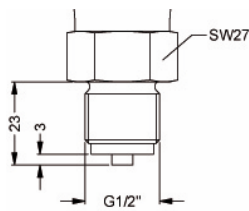

G1/2" EN 837

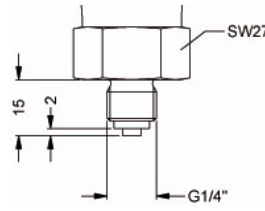

G1/4" EN 837

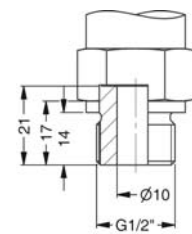

G1/2" open port
DIN 3852

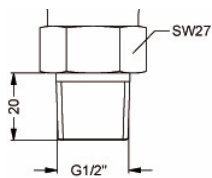

1/2" NPT

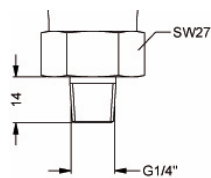

1/4" NPT

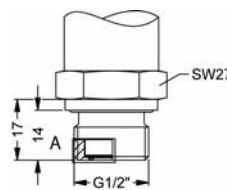

G1/2" flush DIN 3852
(P_N from 0.4 up to 40 bar)

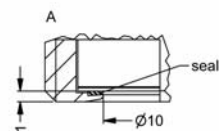

⇒ metric threads and other versions on request

© 2019 BD|SENSORS GmbH – The specifications given in this document represent the state of engineering at the time of publishing. We reserve the right to make modifications to the specifications and materials.

